

# SMART GRID СИСТЕМИ ТА ТЕХНОЛОГІЇ SMART GRID SYSTEM AND TECHNOLOGY

УДК 621.31

S. Denysiuk, Dr. Sc. Sciences, prof., V. Opryshko, As. Ph.D student.,  
National Technical University of Ukraine “Igor Sikorsky Kyiv Polytechnic Institute”  
R. Strzelecki, Dr. Sc. Sciences, prof.,  
Electrotechnical Institute Warsaw

## THE SMART GRID CONCEPT IMPLEMENTATION BY EXPANDING THE USE OF DEMAND SIDE MANAGEMENT AND MODERN POWER ELECTRONIC INSTALLATIONS

*Modern trends in electricity supply grids aimed on intellectualization of existing grids, energy supply and creating Smart Grid systems to ensure a high level of reliability and power quality. As part of the Smart Grid concept demand side management programs play an important role in solving technical and technological problems in concept implementation process. The grid must implement a catena of demand side management programs by providing various services according to the situation, requirement contracts, forecasting of consumption/demand and collect information about energy savings. This requires the study of existing and development of new programs. According to traditional grid in Smart Grid transformation appears the wide-spread use of modern power-electronic installations in electrical power grids. Research of existing models and structures provide base for installations improvements and trends understanding. Proposed practical solutions for power electronics arrangements, either dedicated or capable of adaptation to the distribution systems.*

**Keywords:** Smart Grid; demand side management; power grids; power-electronic.

### Introduction.

Smart power grid is an intelligent electrical grid used for improving efficiency, sustainability, flexibility, reliability and security of the electrical system by enabling the grid to be observable, controllable, automated and fully integrated [1].

In contrast with the existing electrical grids, the intelligent electric grids have digital structure, two-way communication, distributed generation, numerous sensors, self-monitoring, self-healing capabilities, remote checks/tests, pervasive control and many customers fig. 1 [2].

The Smart Grid is more than any one technology, and the benefits of making it a reality extend far beyond the power system itself.

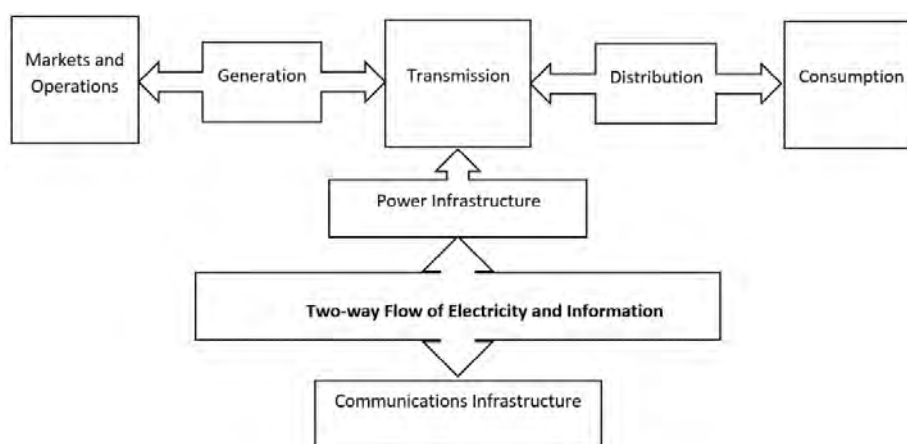

Fig. 1 Smart Grid structure

The transition from the grid we know today to the grid of tomorrow will be as profound as all of the advances in power systems over the last hundred years, but it will take place in a fraction of that time. It will require a new level of cooperation between industry players, advocacy groups, the public and especially the regulatory bodies that have such immediate influence over the direction the process will take. In the end, though, a fully realized Smart Grid will benefit all stakeholders [3].

**Aim of the article.**

Formation of an overarching framework of Smart Grid. Research of existing demand side management programs and formation of demand side management structure for region. Power-electronic installations application in Smart Grid networks analysis. Provide examples of power-electronic installations for existing systems.

Up until now smart integration of grid-connected photovoltaic (PV) systems is a concept that has been neglected in part due to the availability of subsidies. These subsidies given under different forms of national incentive schemes have made PV the fastest growing energy source in the last few years. In the future, as direct financial incentives and other types of subsidies to PV systems are gradually phased out, smarter grid interface will become an essential feature of future PV systems design.

Renewable energy systems (RESs) cannot directly replace the existing electric energy grid technologies. The latter are far too well established to abandon, while the new technologies are not sufficiently developed to meet the total energy demand. Therefore, it is sensible to gradually infuse renewable energy sources into existing grids and transform the system over time [4].

A smart information grid the energy internet for the electric grid is seen as necessary to manage and automate this new world. Smart Grid concepts encompass a wide range of technologies and applications. Early stage in the development of Smart Grids, the role of control, especially advanced control, is limited [46]:

1) Advanced metering infrastructure (AMI) is a vision for two-way meter/utility communication. Two fundamental elements of AMI have been implemented. First, automatic meter reading (AMR) systems provide an initial step toward lowering the costs of data gathering through use of real-time metering information. Second, meter data management (MDM) provides a single point of integration for the full range of meter data. It enables leveraging of that data to automate business processes in real time and sharing of the data with key business and operational applications to improve efficiency and support decision making across the enterprise.

2) Distribution management system (DMS) software mathematically models the electric distribution grid and predicts the impact of outages, transmission, generation, voltage/frequency variation, and more. It helps reduce capital investment by showing how to better utilize existing assets, by enabling peak shaving via demand response (DR), and by improving grid reliability.

3) Geographic information system (GIS) technology is specifically designed for the utility industry to model, design, and manage their critical infrastructure. By integrating utility data and geographical maps, GIS provides a graphical view of the infrastructure that supports cost reduction through simplified planning.

4) Outage management systems (OMSs) speed outage resolution so power is restored more rapidly and outage costs are contained.

5) Intelligent electronics devices (IEDs) are advanced, application-enabled devices installed in the field that process, compute, and transmit pertinent information to a higher level. IEDs can collect data from both the grid and consumers' facilities (behind the meter) and allow grid reconfiguration either locally or on command from the control center.

6) Wide-area measurement systems (WAMS) provide accurate, synchronized measurements from across large-scale power grids. WAMS consist of phasor measurement units (PMUs) that provide precise, time-stamped data, together with phasor data concentrators that aggregate the data and perform event recording.

7) Energy management systems (EMSs) at customer premises can control consumption, onsite generation and storage, and potentially electric vehicle charging. EMSs are in use today in large industrial and commercial facilities and will likely be broadly adopted with the rollout of Smart Grids.

In terms of market reforms any energy company that aims to be popular, requires modern IT technologies, which ensure it highly competitive and effective management of business processes. Implementation of enterprise informational platforms can quickly obtain the necessary data on the current affairs in the company, develop tactics and strategy of its development, manage personnel and predict future sectoral changes and prepare for them in time.

Relevance of the change in strategy of supply companies due to the new level of grid management, ensuring guaranteed efficiency and reliability of the distribution electric grid complex [6]. The key to the success of any energy company is its customer-oriented strategy. As any services must meet customer needs, market allows the client to choose. Preferences motives may be different, but the determining factor is the ratio between the electricity price and the risk level. Everyone chooses a risk level that may afford. An example of such balancing is demand management programs, Demand Side Management (DSM) that do not require significant investment

from the energy supply companies. DSM is traditionally seen as an instrument to reduce peak demand in electricity grid.

By reducing the overall load in grid, DSM can reduce the number of accidents by reducing the number of disconnections and increase system reliability [7].

DSM allows customers to make informed decisions regarding their energy consumption, helps the energy providers to reduce the peak load demand and reshape the load profile [8]. DSM is carried through demand task scheduling, usage of stored electric energy and real-time pricing [9].

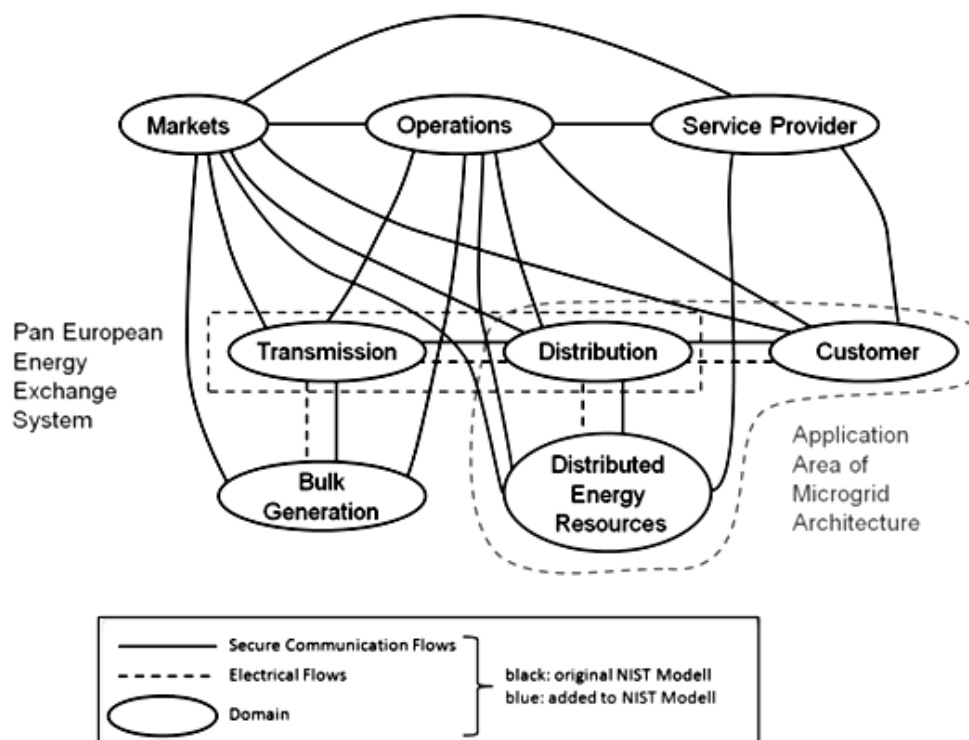

Fig. 2 European Union extension of the NIST Model [5]

DSM techniques increase the operational complexity of the power system, redistribute the load but do not reduce the total energy consumed by the appliances [10, 11]. In case of loading the system with its max capacity, the value of DSM is high. Otherwise, it is low in systems with spare capacity. For this reason, the generation capacity of electricity grid represents the main challenges for DSM [10, 12]. On the one hand, the lack of knowledge about demand response (DR) programs, the response fatigue caused by keeping track of frequently varying prices and the extensive payback time for recovering the installation costs of smart meters are considered as consumer-based barriers [13, 14].

On the other hand, the existence of substantial confusion about whose responsibility the promotion of DR programs is, the loss of revenue for firm due to the lowering peak usage in case the electricity is more expensive and the lack of measures for the recovery of initial investment in DR infrastructure are regarded as producer-based barriers [13, 15]. In some countries, it is difficult to establish a unified standard policy system due to the imbalance regional development of DSM [16]. In addition, are bound of energy use after high price signal can caused bigger peaks appearance in DSM [17].

As an important branch of DSM, DR (Fig. 2) can be viewed as a new development of DSM with power market and SG technology evolution. According to [18], DR refers to changes in electric use by demand-side resources from their normal consumption patterns in response to electricity price changes, or to incentive payments designed to induce lower electricity use at times of high wholesale market prices or when system reliability is threatened. Thus DR programs can be classified into incentive-based ones (DLC, IL, DSB, EDR and CASP) and price-based ones (TOU, RTP and CPP).

Specific classification of DRPs is shown in Fig. 3. In those listed in Fig. 3, DLC, IL, TOU and RTP are the most common DRPs, among which RTP is the most ideal form of DRP.

Numerous studies conducted in France and other countries have found that cost-effective demand management software make it possible to reduce energy consumption and peak demand by about 20% without centralized control [17].

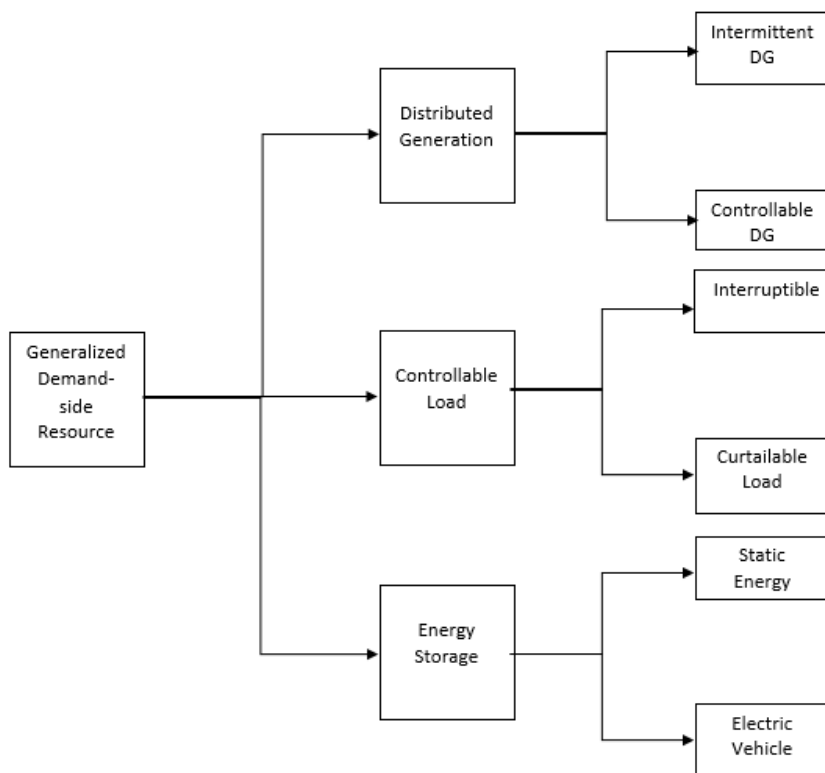

Fig. 3. Classification of DRPs

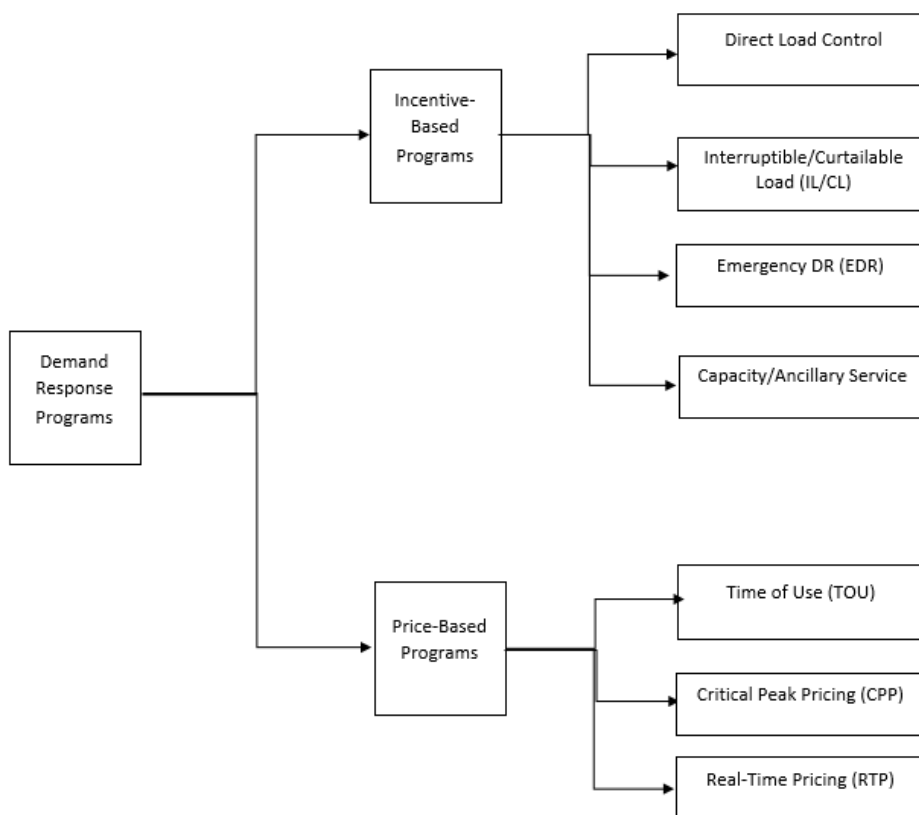

Fig. 4 Classification of DRPs

With DSM programs not only households, businesses and municipal structures receive benefit but also the general public, such as [19]:

- 1) reducing bills for electricity from consumers;

- 2) reducing the demand for construction of new facilities;
- 3) promote economic development;
- 4) the creation of long-term jobs that benefit the economy;
- 5) increase of competitiveness of local businesses;
- 6) reduced maintenance costs and replacement of equipment;
- 7) reducing air pollution locally;
- 8) the emission reductions affecting national and international environmental issues such as global warming;
- 9) strengthening national security by easing dependence on external energy sources;
- 10) increased comfort and a working space, which in turn can increase productivity;
- 11) promoting market reforms with long-term results.

Management in Smart Grid has to implement a number of DSM programs by providing various services according to the situation and contracts requirements, including cooperation EV-EMS, FEMS and HEMS, consumption forecasting and supply and energy savings information collection. Consideration of various energy management concepts types according to Smart Grid enabled services classification by DSM system level. In Table. 1 shows the level of system elements for which these services are intended.

Control storage equipment efficiently by distribution level energy management system (D-EMS) in addition to distribution management system (DMS) to utilize renewable energy.

Realize DSM by providing various services according to the usage situation and contract terms such as data cooperation with demand side (such as EV-EMS, FEMS and HEMS) and provision of supply and demand forecast and power saving information.

Table 1 – Levels of services integration

System lvl	System element	Services
Power system	Large-scale centralized power Renewable Energy Energy storage batteries	EMS – Energy Management System
Distribution system	Distribution system level energy management	DMS – Distribution Management System
		CEMS – Community Energy Management System
		D-EMS Distributed Energy Management System
		DSM – Demand Side Management
User	Region/Customers	HEMS – Home Energy Management System
		AMI – Advanced Metering Infrastructure
		FEMS/BEMS – Factory Energy Management System
		EV-EMS Electric Vehicle Energy Management System

Support minimum energy to keep up life even during an emergency. Introduce each function of CEMS and demand side according to the object function and scale step-by step and partially by autonomous decentralized system.

Controllability and responsiveness of highly distributed resources and assets within electric power systems. Renewable generation will make an increasingly important contribution to electric energy production into the future. Integration of these highly variable, widely distributed resources will call for new approaches to power system operation and control.

Likewise, new types of loads, such as plug-in electric vehicles and their associated vehicle-to-grid potential, will offer challenges and opportunities [20].

The EU's Smart Grids technology platform summarizes the benefits of Smart Grids as follows. They [4]:

- 1) better facilitate the connection and operation of generators of all sizes and technologies;
- 2) allow consumers to play a part in optimizing the operation of the system;
- 3) provide consumers with greater information and options for choice of supply;
- 4) significantly reduce the environmental impact of the whole electricity supply system;
- 5) maintain or even improve the existing high levels of system reliability, quality and security;
- 6) supply, maintain and improve the existing services efficiently and foster market integration.

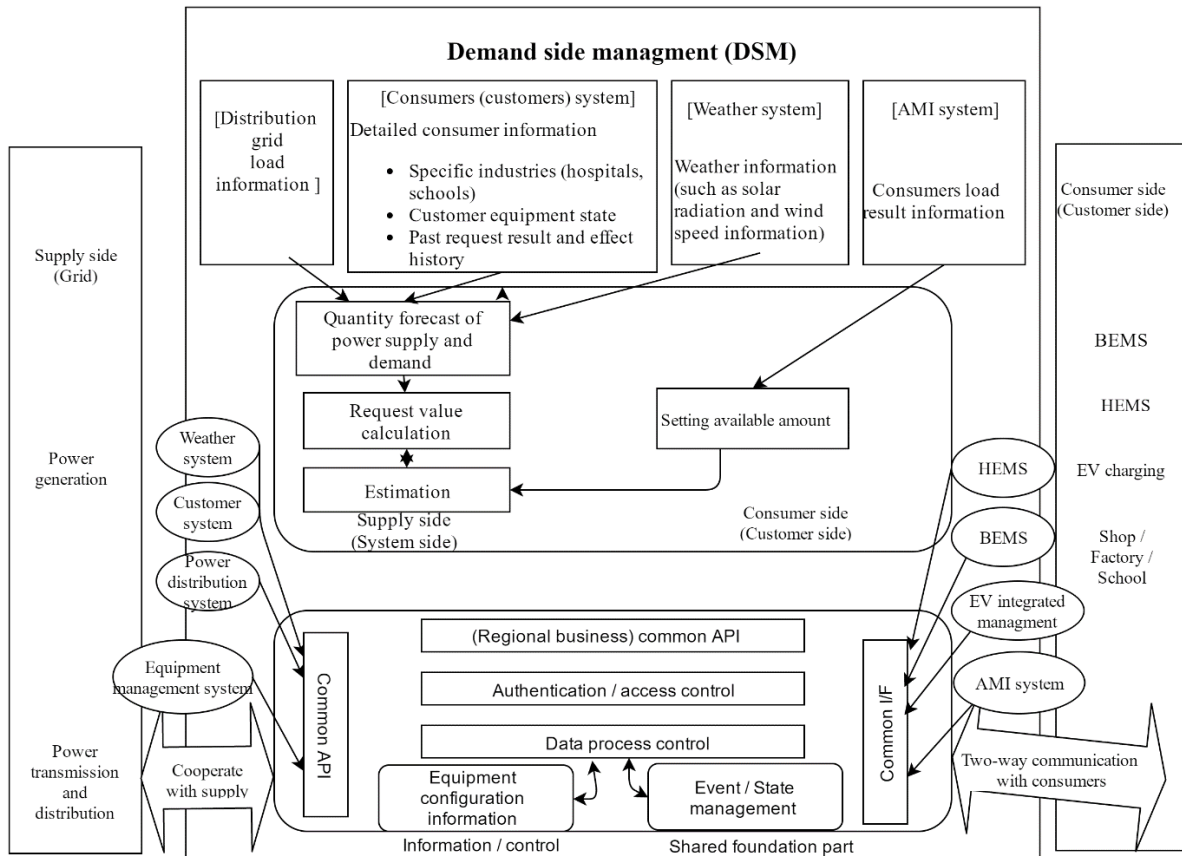

Fig. 5 Demand side management structure for region

One of the basic conditions of transforming a traditional grid to Smart Grid is the wide-spread use in electrical power grids of modern power-electronic installations (PI), in which there are installations of the type FACTS (Flexible AC Transmission System) and HVDC (High Voltage DC) [3–5], either M (Medium)VDC or L(Low)VDC, as well as a great many installations of the type CPS (Custom Power Supply) [6]. Widespread use of PI is recommended also in modernized traditional grid. For example, switchgear equipment used up to the present is in the majority of cases mechanical devices. Their speed of operation is satisfactory for the control of European power network (EPN) in given situations, but is inadequate in situations demanding reactions to unexpected changes in voltage and flow conditions. This negative feature of mechanical devices is particularly demonstrable in response to ever-increasing demands in the area of quality of electrical energy [7–9]. A wider application of PI in grid today would allow for a fuller exploitation of existing distribution and transmission resources, while maintaining the status so far, and even improving the safety of the power supply and energy efficiency.

The area of PI application in Smart Grid can be generally divided into:

- 1) electrical energy transmission system;
- 2) electrical energy distribution system.

The transmission system is composed basically of two complementary technologies for controlling the transmission of energy [5]:

- 1) with conversion to DC current – HVDC devices;
- 2) directly – FACTS devices.

An advantage of HVDC devices is the capability to transmit energy between systems of various frequencies. However, in the case of conventional HVDC, i.e., with the use of SCR thyristors, it is necessary to use large filters and there is no possibility of supplying power to end-users on the side from which the source is disconnected. This drawback does not occur when using modern devices, such as GTO thyristors or IGBT transistors [30]. Here, one should note that with HVDC devices the entire energy from one system flows into the other through converters. As a result of this the cost is high, even in single-station installations. While in FACTS devices, such as: SVC (Static Var Compensator) and STATCOM (Static Synchronous Compensator), TCSC (Thyristor Controlled Series Compensator), TSSC (Thyristor Switched Series Compensator) and SSSC (Static

Synchronous Series Compensator), SPS (Static Phase Shifter), supply voltage, as well as compensation for distortion, asymmetry and phase shift in load current.

The most frequent area of application of PI in wind installations is in generators [10,11]. In the beginning the most commonly applied device was the squirrel cage induction machine (IM) connected directly to an EPN, and power-electronics used solely in a simple connection-starting device. As a result, in such installations there occurs a transfer of the pulsation of the wind power to the power grid and, moreover, there is no means of direct control of the active and passive power. The significance of such control, desirable for the control of voltage and frequency in an EPN, increases along with the rise in power [10,12]. As a result of this, generators with squirrel cage induction machines connected directly to an EPN are sporadically applied to new installations of large power. Rarely installed too, on account of power losses and limited means of regulation, are generators with wound rotor induction machines (WRIM) and power-electronic adjustable resistance in the rotor circuit [13].

Popular turbines uses are:

1) double feed wound rotor induction machines (DFIM) with an AC–DC/DC–AC converter in the rotor circuit,

2) synchronous machines (SM) with an AC–DC/DC–AC converter in the main line and an AC–DC/DC–AC converter in the exciter circuit,

3) permanent magnet synchronous machine (PMSM) and AC–DC/DC–AC converter in main line. There are also generators with squirrel cage induction machines (IM) but with self-excitation and an AC–DC/DC–AC converter in the main line (designed for full power) [13–15]. All these solutions, although more costly than the ones applied at the beginning of the development of wind power in Poland, are characterized by much better regulatory qualities, among which are: the capability of adjusting active and passive power; the capability of operating at varying shaft rotation speeds, rapid reaction to change of wind conditions (0.5–1 ms); avoiding influence and resistance to deteriorating quality of EE in an EPN; and the capability to work in islanding mode [10,12]. These aspects support the implementation of the vector control method applied originally to the motor drives [16–18], as well as the MPPT (Maximum Power Point Tracking) algorithms enabling full use of the available wind energy [14]. Multipolar SM and PMSM permit through this the elimination of a mechanical transmission system, which raises the reliability of the turbine. Heavy-duty power-electronic converters are equally employed on wind farms, taking care of at least a few connected turbines situated close by. The configuration of farms is equally dependent on the kind of generator as well as the type of converter used and the topology of the EPN [10–12].

Energy storage, in the form of batteries, is widely used in backup power supplies. In such devices flywheels exploit greater power [18], amassing kinetic energy.

Quite small fast-rotating kinetic storage resources are connected to an internal DC bus through an AC–DC converter, and only then through a DC–AC converter to an AC line. It should be emphasized that the greatest difficulty in constructing a modern kinetic storage is tied not to power-electronics, but to high-speed flywheel rotation technology (60,000–90,000 RPM). Batteries, flywheels and other storage, such as: water containers, hydrogen systems, heat energy storage, supercapacitors, superconductive storage or compressed air tanks are also used in distributed sources [2,20]. The goal is the improvement of the availability of these sources, i.e., the amelioration, or even elimination of the influence of external conditions (weather) on the power temporarily supplied to the EPN. For the connection of such resources to the grid various PI are employed

The degree of compensation depends on the size and dynamic qualities of the energy storage as well as the control algorithm used [21]. This in turn has an influence on the power of the converter, the type of which is chosen with respect to bidirectional energy flow and kind of energy storage. For example, for batteries it will be an AC–DC converter, and for a flywheel with an AC motor, an AC–AC converter. The power of the converter depends, too, on its additional functions, e.g., its passive power compensation efficiency. In the case of the exploitation of energy storage and low-voltage sources, the configuration of the source and the means of matching the voltage levels have a decisive influence on the qualities of the chosen solution. Typical examples here would be a power supply with a photovoltaic cell (PV) and a fuel cell (FC) [22–24], in spite of the fact that such cells, in contrast to energy storage, do not have the capability for bidirectional energy flow. PV systems are differentiated by three basic connection configurations.

The most demanding in respect to the PI, is a configuration with a modestly sized DC–AC converter integrated into the PV module. The converter should be characterized by: very high efficiency and minimal size, increased voltage cell and sinusoidal output voltage as well as the ability to work with parallel connections. These requirements enable the connection to various PI with impulse modulation [22,23,25–29], realized on the basis of currently available power-electronic components [30–33]. In conventionally configured PV systems, generally of greater power, an internal DC bus is frequently used. A DC bus also permits easier galvanic isolation of the PV cell with the help of high frequency transformers and in addition, may be an integrated part of

the internal direct current microgrid [34–37]. In a similar way to the PV system, with the use of a geminate PI and DC bus, systems with FC elements are likewise configured [24,38]. In this case, taking into consideration the soft output characteristics and low voltage of individual cells, the connection of fuel cells in the stack is of decisive significance to the required output voltage and load capabilities.

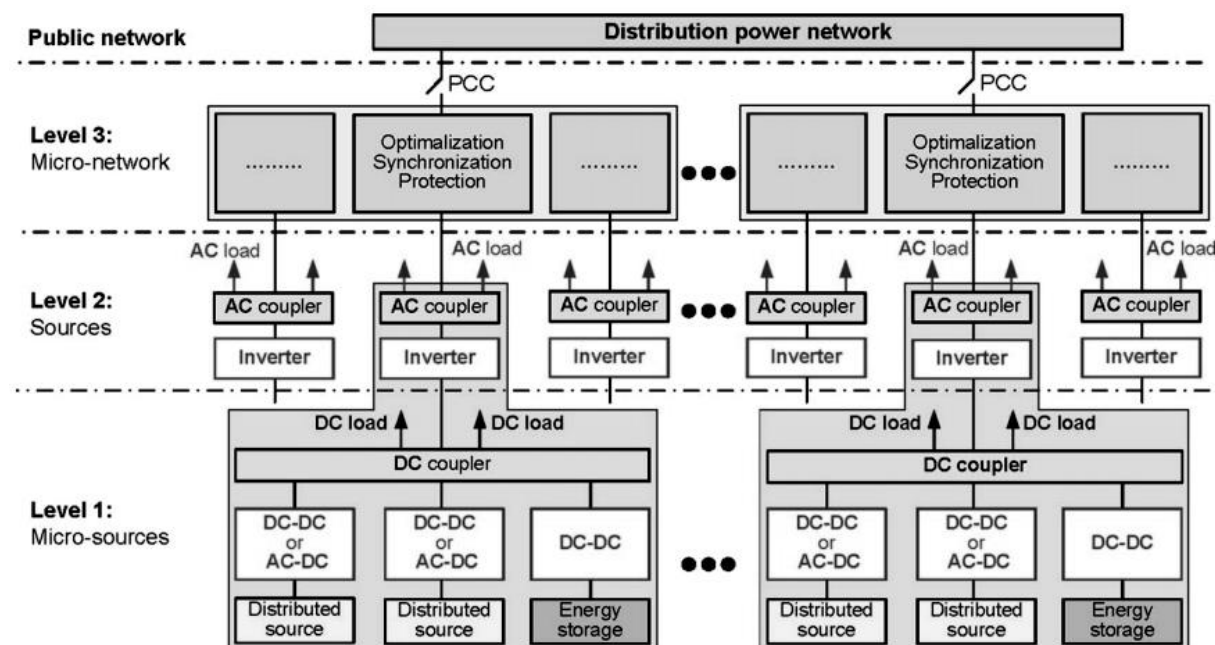

Fig. 6 Public network level structure

Because grid transformers increase in a significant way the size of coupling installations, there has been quite recently development of new coupling devices with galvanic separation, aided by DC–DC converters with a high-frequency transformer [50]. The idea of such devices, known also as integrated distribution transformers [51]. Each phase consists of  $M$  identical AC–DC–AC–Tr–AC–DC–AC converter cells, series connected on the side of the higher voltage, and in parallel, on the side of the lower. Possible are other cell connections, by which it is always necessary to ensure equal loading and equal voltages. It is estimated that high power and medium voltage integrated distribution transformers, ensuring the same functional capabilities as typical “back-to-back” couplers, will be about one third the size of conventional transformers. Modern PIs serving to couple AC and DC grids as well as to match distributed sources and energy storage already today enable the building of local micro-grids as a part of an IEPN [2,34–37,52]. For example, if we consider the micro-grid structure, we gain a highly flexible integration of distributed sources and the capability of “plug-and-play” type functions at every level, without the necessity of implementing non-standard solutions. Here it is understood that the most effective working conditions of the power grid (with a micro grid in it) occur in the case of steady loads with a power coefficient of  $1$  [8]. With the aim of improving the coefficient  $1 < 1$ , on the output or directly on the input (load), various compensatory-filter devices are installed. Among the implemented solutions [8,53], the most universal are active power filters (APF) [8,9,19,41,42,53,54]. APF devices, depending on the control algorithm, enable a connection that the UPQC device may also function as a DVR, but such a solution is unnecessary and uneconomical. A smaller energy storage is likewise necessary in inter-line DVR devices, which results from the possibility of exchanging active power between power lines.

**As a result of research:**

Presented main early stages in Smart Grid development. Actualized the DSM evolution in market reform period. Given specific classification of the DRPs where compeers the most common programs which RTP is most ideal form of DRP. Concluded DSM benefits for households and ore structures. Conducted DSM services according to system level organization. Demand side management structure for regional energy management system. EU's Smart Grids technology platform benefits overviewed. Analyzed the application of PI in Smart Grid. Important is the fact that such PI can usually fulfill many different functions connected with conditioning of the EE. This all means that power electronic technology oriented towards EPN leads significantly over traditional technologies, supported by passive LC elements and mechanical switch-coupling devices.



### References

- [1] UK Department of Energy and Climate Change. Smarter grids: the opportunity, December [Online]. Available: ([http://www.techuk-e.net/Portals/0/Cache/\(DECC\)SmartGrid\\_web.pdf](http://www.techuk-e.net/Portals/0/Cache/(DECC)SmartGrid_web.pdf)); 2009.
- [2] US Department of Energy. Smart Grid system report, July [Online]. Available: ([http://energy.gov/sites/prod/files/oeprod/DocumentsandMedia/SGSR\\_Annex\\_A-B\\_090707\\_lowres.pdf](http://energy.gov/sites/prod/files/oeprod/DocumentsandMedia/SGSR_Annex_A-B_090707_lowres.pdf)); 2009.
- [3] Smart grids European Technology Platform. Strategic deployment document for Europe's electricity grids of the future, April [Online]. Available: [http://www.smartgrids.eu/documents/SmartGrids\\_SDD\\_FINAL\\_APRIL2010.pdf](http://www.smartgrids.eu/documents/SmartGrids_SDD_FINAL_APRIL2010.pdf); 2010.
- [4] Eduardo F. Camacho, Tariq Samad, Mario Garcia-Sanz, and Ian Hiskens Control for Renewable Energy and Smart grids
- [5] [CEN-CENELEC-ETSI Smart Grid Coordination Group Smart Grid Reference Architecture November 2012.
- [6] Denysiuk S.P. Opryshko V.P Assessment of energy sector companies innovation management effectiveness promising problems of economics and management Montreal, Canada, 2015
- [7] International Scientific Conference: Energy savings, energy efficiency and energy audit in Ukraine. 21st October. Modern problems of energy efficiency in Ukraine and building of energy management system.
- [8] Logenthiran T, Srinivasan D, Shun T Z. Demand side management in Smart Grid using heuristic optimisation. *IEEE Trans Smart Grid* 2012; 3 (3) :1244–52.
- [9] Koutsopoulos I, Tassiulas L. Challenges in demand load controlfortheSmart Grid. *IEEE Netw* 2011; 25 (25): 16–21.
- [10] Strbac G. Demand side management: benefits and challenges. *Energy Policy* 2008;36(12):4419–26.
- [11] Khodayar M E,Wu H. Demand forecasting in the Smart Grid paradigm: features and challenges. *Electr J* 2015; 28(6): 51–62.
- [12] Saad W, Han Z, Poor H V, Basar T. Game-theoretic methods for the Smart Grid: an overview of microgrid systems, demand-side management, and Smart Grid communications. *IEEE Signal Process Mag*2012; 29(5):86–105.
- [13] Kim J H, Shcherbakova A. Common failures of demand response. *Energy* 2011;36(2):873–80.
- [14] Spees K, Lave L B. Demand response and electricity market efficiency. *Electr J* 2007; 20(3): 69–85.
- [15] Wang J, Bloyd C N, Hu Z, Tan Z. Demand response in China. *Energy* 2010; 35 (4):1592–7.
- [16] Ming Z, Li S, Yanying H. Status, challenges and counter measures of demand- side management development in China. *Renew Sustain Energy Rev* 2015; 47: 284–94.
- [17] Gelazanskas L, Gamage K A A. Demand side management in Smart Grid: a review and proposals for future direction. *Sustain Cities Soc*2014; 11:22–30.
- [18] Ghicajanu M. Programs of energy efficiency - Demand Side Management [Text] / M. Ghicajanu. – [International conference on economics, law and management]. - 2008.
- [19] Barbato A. A Power Scheduling Game for Reducing the Peak Demand of Residential Users Online Conference on Green Communications (GreenCom) [Text] / A. Barbato. – IEEE, 2013.
- [20] Marco Liserre, Thilo Sauter, and John Y. Hung, “Future Energy Systems”, *IEEE Industrial Electronics Magazine*, March 2010
- [21] Lubos’ny Z. *Elektrownie wiatrowe w systemie elektroenergetycznym*. Warszawa: Wyd. Naukowo-Techniczne; 2006.
- [22] Blaabjerg F, Chen Z. *Power electronics for modern wind turbines*. Morgan & Claypool; 2006.
- [23] Heier S, Waddington R. *Grid integration of wind energy conversion systems*. Wiley Blackwellm; 2006.
- [24] Simoes MG. *Renewable energy systems. Design and analysis with induction generators*. CRC Press; 2004.
- [25] Boldea I. *Variable speed generators*. Taylor & Francis Group; 2006.
- [26] Gientkowski Z. *Autonomiczne prądnicie indukcyjne o wzbudzeniu kondensatorowym i przekształtnikowym*. Bydgoszcz: Wydawnictwa Uczelniane ATR w Bydgoszczy; 1997.
- [27] Bose BK. *Power electronics and motor drives: advances and trends*. Academic Press; 2006.
- [28] Quang NP. *Vector control of three-phase AC machines: system development in the practice*. Springer; 2008.
- [29] Kazimierkowski M, Krishnan R, Blaabjerg F. *Control in power electronics*. Academic Press; 2002.
- [30] Emadi A, Nasiri A, Bekiarov SB. *Uninterruptible power supplies and active filters*. CRC Press; 2005.
- [20] Guerrero MA, Supercapacitors:. *Alternative energy storage systems*. *Przegląd Elektrotechniczny* 2009;85(10):188–95.
- [31] Sourkounis C, Ni B, Richter F. Comparison of energy storage management methods to smooth power fluctuations of wind parks. *Przegląd Elektrotechniczny* 2009;85(10):196–200.

- [32] Blaabjerg F, Chen Z, Kjaer SB. Power electronics as efficiency interface in dispersed power generation systems. *IEEE Trans Power Electron* 2004;19(5):1184–94.
- [33] Dunlop JP. Photovoltaic systems. American Technical Publication; 2009.
- [34] Enjeti P, Palma L, Todorocic MH. Power conditioning systems for fuel cell applications. John Wiley & Sons; 2009.
- [35] Lai JS. Power conditioning circuit topologies. *IEEE Ind Electron Mag* 2009;3(2):24–34.
- [36] Luo FL. Essential DC/DC converters. CRC Press; 2006.
- [37] Calais M, Myrzik J, Spooner T, Agelidis VG. Inverters for single-phase grid connected photovoltaic systems – an overview. *Conf Proc PESC 2002*;4(23– 27):1995–2000.
- [38] Huang Y, Shen M, Peng FZ, Wang J. Z-Source inverter for residential photovoltaic systems. *IEEE Trans Power Electron* 2006;21(6):176–82.
- [39] Strzelecki R, Bury W, Adamowicz M, Strzelecka N. New alternative passive grids to improve the range output voltage regulation of the PWM inverters. *Conf Proc APEC 2009*;857–63.
- [40] Januszewski S, S'wiątek H, Zymmer K. Przyrządy energoelektroniczne i ich zastosowania. Warszawa: Wyd. Książkowe Instytutu Elektrotechniki; 2008.
- [41] Kazimierczuk MK. High frequency magnetic components. John Wiley & Sons; 2009.
- [42] Emadi A. Integrated power electronic converters and digital control. CRC Press; 2009.
- [43] Liu W, Dirker J, van Wyk JD. Power density improvement in integrated electromagnetic passive modules with embedded heat extractors. *IEEE Trans Power Electron* 2008;23(6):3142–50.
- [44] Ito Y, Zhongqing Y, Akagi H. DC microgrid based distribution power generation system. *Conf Proc IPEMC 2004*;3:1740–5.
- [45] Lasseter R, Paigi P. Microgrid: a conceptual solution. *Conf Proc PESC 2004*;6:4285–90.
- [46] Ise T. Advantages and circuit configuration of a DC Microgrid. In: Proc. of the symposium on microgrids; 2006. [37] Kakigano H. In: Fundamental characteristics of DC micro-grid for residential houses with cogeneration system in each house; 2008.p. 1–8.
- [46] T.Samad and A.M. Annaswamy, “The Impact of control technology- Control for renewable energy and Smart Grid” [www.ieeecss.org](http://www.ieeecss.org). (eds), 2011.

**УДК 621.31**

**С.П. Денисюк**, д-р техн. наук, проф., **В.П. Опришко**, асп.,

**Національний технічний університет України «Київський політехнічний інститут імені Ігоря Сікорського»**

**Ришард Стшелецькі**, д-р техн. наук, проф.

**Електротехнічний інститут, Варшава**

### **РЕАЛІЗАЦІЯ КОНЦЕПЦІЇ SMART GRID ЗА РАХУНОК ВИКОРИСТАННЯ ПРОГРАМ З КЕРУВАННЯ ПОПИТУ І СУЧАСНИХ СИСТЕМ СИЛОВОЇ ЕЛЕКТРОНІКИ**

*Сучасні тенденції в мережах електропостачання спрямовані на інтелектуалізацію існуючих мереж енергопостачання та створення систем Smart Grid для забезпечення високого рівня надійності та якості електроенергії. В рамках програм з керування попитом, концепція Smart Grid відіграє важливу роль в рішенні технічних і технологічних проблем в процесі реалізації даної концепції. Мережа електропостачання повинна реалізувати низку програм керування попитом шляхом надання різних послуг в залежності від ситуації, вимог контрактів, прогнозування споживання / попиту і наявної інформації про рівень економії енергії. Це вимагає детального аналізу існуючих і розробки нових програм. Згідно концепції Smart Grid все більшого використання в розподільних мережах отримують сучасні устаткування силової електроніки. Дослідження існуючих моделей і конструкцій забезпечують базу для удосконалення існуючих конфігурацій та розуміння сучасних тенденцій в галузі.*

**Ключові слова:** Smart Grid; керування попитом; електричні мережі; силова електроніка.

Надійшла 15.12.2016

Received 15.12.2016

# ЕНЕРГЕТИЧНІ СИСТЕМИ ТА КОМПЛЕКСИ ENERGY SYSTEMS AND COMPLEXES

УДК 621.311

V. Stepashko, Dr. Sc. Sciences, prof., A.Trachuk, Ph.D. student  
National Technical University of Ukraine "Igor Sikorsky Kyiv Polytechnic Institute"

## MODELLING OF COAL CONSUMPTION IN UKRAINE BY USING THE GROUP METHOD OF DATA HANDLIN

*This paper deals with issues of coal consumption in Ukraine. The dynamics of consumption of coal is analysed and proposed guidelines for the efficient production, consumption and use of coal in Ukraine. Constructed and developed predictive models of coal consumption in Ukraine through the use of modern software and using the group method of data handling, which allowed building adequate predictive models of coal consumption in the system of Ukraine's energy balance. Researched and forecasted scenarios of coal consumption in the Ukraine.*

**Keywords:** energy conservation, energy efficiency, energy balance, energy statistics.

### Introduction

The problem of efficient use of energy resources is critical for sustainable economic development against the backdrop of energy saving national economy depends on energy imports, on the one hand, and rising prices for these resources. The basic foundation of the formation energy system of Ukraine is to build forecasting scenarios for different types of energy and different criteria for effective use of energy resources. Solving this problem is not only with ensuring energy security, but also with the level of development of regions of Ukraine and ensuring quality of life.

Forecasting coal consumption in Ukraine today is the extremely important issue of strategic importance since conducted through analysis and building predictive models will be possible to develop guidelines for the efficient production and consumption of coal throughout Ukraine as a whole.

### Formulation of the problem.

Construction and development of predictive models of coal consumption in Ukraine using the group method of data handling and by using modern software.

### Analysis of recent research and publications.

In [3] shows the comparison as previously proposed and those developed methods for short-term forecasting of coal consumption, regression analysis, neural networks and fuzzy neural networks. Intensive development of software products aimed at forecasting coal consumption [4], theory and practice modeling, forecasting processes in new ways raises the question of developing a new multi multivariate predictive model that takes into account more parameters and factors unlike the existing ones.

We consider the system of forecasting coal consumption in Ukraine, built on the basis of group method of data handling.

### The aim of the study.

The purpose of research is to develop methodical positions on prediction of coal consumption in Ukraine using Multi method of data handling.

### Material and research results

Changes in energy prices immediately reflected in all industries, and the rest - the price of the final product. The level of energy has a decisive impact on the economy of the state, resolving social problems and living standards of citizens. So instead of quantitative energy objectives underlying Ukraine's economy in recent decades, energy has to go to power sustainable economic development, as they are focused now in developed countries. The said research leads scientists to balance the energy balance of Ukraine, which determined the relevance of the work. In the traditional understanding of energy balance is the ratio between the extraction (production) and consumption of different types of energy resources.

At the heart of the development of fuel and energy balance is a set of strategic statements of economic development, the definition of forecast volumes of energy consumption, based on adopted policies to increase energy efficiency, the development of fuel and energy complex and evaluating opportunities extraction and

production of fuel and energy, as well as the formation of areas of import- export policy and determine the volume of purchase and sale of energy.

One of the mathematical methods of forecasting is group method of data handling, which allows you to build adequate predictive models of energy consumption in the system of Ukraine's energy balance.

With the help of a group method of data handling and by using modern software were built predictive models of coal consumption in the system of Ukraine's energy balance:

1. Forecasting System Model 2 lags:

$$Y(1)=0,37837*Y1(-1)+ 0,576431*Y1(-2)+0,13327*Y2(-2)$$

$$Y(2)=0,135461*Y2(-1)+1,52816*Y2(-2)+11,8371*Y3(-1)-18,2873*Y3(-2)+0,590244*Y4(-1) \quad (1)$$

$$Y(3)=1,41627*Y3(-1)-0,849706*Y3(-2)+0,155252*Y4(-1)$$

$$Y(4)=-0,00552574*Y1(-1)+0,00517918*Y1(-2)+1,35122*Y4(-1)-0,356013*Y4(-2)$$

Initial data for forecasting coal consumption are shown in Table 1

Table 1 - Initial data of coal consumption

Year	Coal production, total, mln t	Consumption of coal, total, mln t	Imports of coal, total, mln t	Ash content of coal shipped, %
	Y1	Y2	Y3	Y4
2006	79,5	61,8	7,9	24,8
2007	81,8	63,1	8,1	24,4
2008	84,3	68,8	8,5	24,0
2009	88,5	72,4	8,9	23,8
2010	90,9	78,9	9,2	23,6
2011	94,7	81,4	9,0	23,4
2012	99,1	83,7	8,6	23,1
2013	103,9	85,1	8,1	22,8
2014	107,5	92,2	7,4	22,5
2015	110,3	98,7	7,0	22,3

1. Forecasting System Model 2 logs:

$$Y(1)=0,37837*Y1(-1)+ 0,576431*Y1(-2)+0,13327*Y2(-2)$$

$$Y(2)=0,135461*Y2(-1)+1,52816*Y2(-2)+11,8371*Y3(-1)-18,2873*Y3(-2)+0,590244*Y4(-1) \quad (2)$$

$$Y(3)=1,41627*Y3(-1)-0,849706*Y3(-2)+0,155252*Y4(-1)$$

$$Y(4)=-0,00552574*Y1(-1)+0,00517918*Y1(-2)+1,35122*Y4(-1)-0,356013*Y4(-2)$$

Results of approximation and forecast for the next 5 years

The first indicator Y1 - Coal production, everything million tons given in Table 2

Table 2 - Coal production, total, mln t

Year	2006	2007	2008	2009	2010	2011	2012	2013
Initial data	79,5	81,8	84,3	88,5	90,9	94,7	99,1	103,9
Forecast			85,01	87,73	91,37	94,87	99,08	102,89

Continuation of Table 2

Year	2014	2015	2016	2017	2018	2019	2020
Initial data	107,5	110,3					
Forecast	107,299	111,26	116,4	121,4	128,6	136,3	147,4

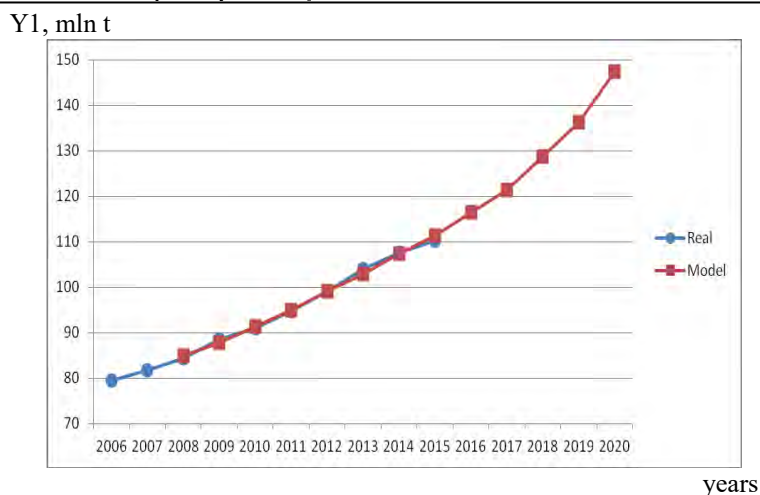

Fig. 1 Predictive model of coal production, mln t, built by group method of data handling

The second indicator Y2 - coal consumption, mln t is given in Table. 3

Table 3 - Consumption of coal, total, mln t

Year	2006	2007	2008		2009	2010	2011	2012	2013	2014
Initial data	61,8	63,1	68,8		72,4	78,9	81,4	83,7	85,1	92,2
Forecast t			68,8		73,02	78,9	80,37	84,48	85,202	93,14

Continuation of Table 3

Year	2015	2016	2017	2018	2019	2020
Initial data	98,7					
Forecast	99,46	117,2	132,6	162,8	189,1	236,2

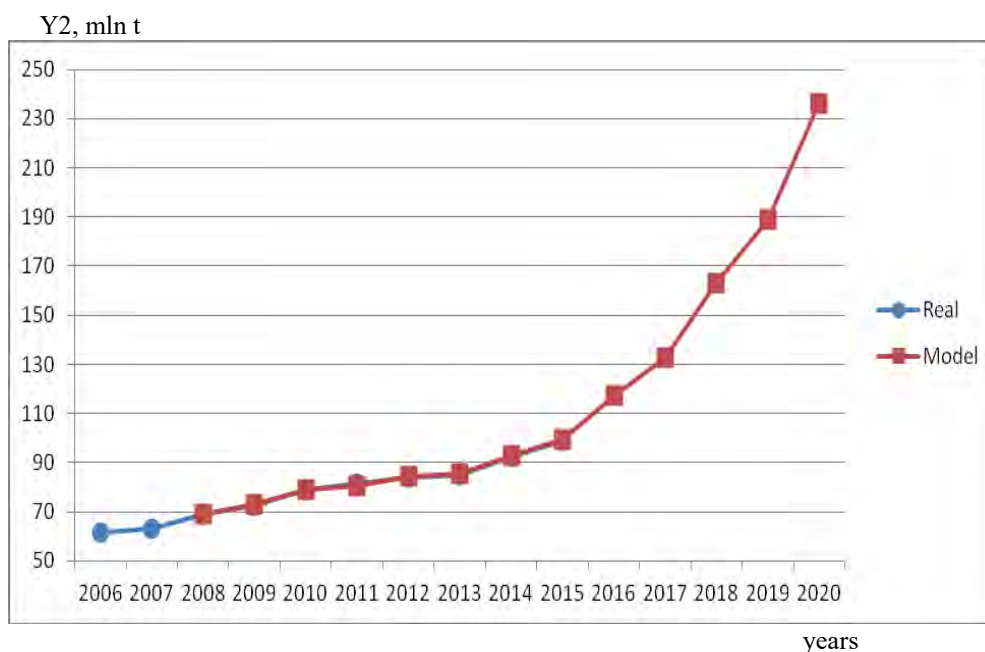

Fig. 2 Predictive model of coal consumption, mln t, built by group method of data handling

The third indicator Y3 – Imports of coal , total, mln t is given in Table. 4

Table 4 - Imports of coal, total, mln t

Year	2006	2007	2008	2009	2010	2011	2012	2013	2014
Initial data	7,9	8,1	8,5	8,9	9,2	9	8,6	8,1	7,4
Forecast			8,547	8,96	9,13	8,98	8,58	8,099	7,725

Continuation of Table 4

Year	2015	2016	2017	2018	2019	2020
Initial data	7					
Forecast	7,56	7,606	7,77	7,92	7,96	7,83

The fourth indicator Y4 - Ash content of coal shipped,% is given in Table 5

Table 5 - Ash content of coal shipped,%

Year	2006	2007	2008	2009	2010	2011	2012	2013	2014
Initial data	24,8	24,4	24	23,8	23,6	23,4	23,1	22,8	22,5
Forecast			24,10	23,83	23,58	23,32	23,07	22,814	22,557

Continuation of Table 5

Year	2015	2016	2017	2018	2019	2020
Initial data	22,3					
Forecast	22,3	22,04	21,78	21,5	21,2	20,9

**Conclusions.** The basic method of building predictive models for coal consumption has been selected the group method of data handling, because through this unique method was possible to build a multidimensional multifactor forecasting model of coal consumption in the system of energy balance in Ukraine, which will take into account all important energy data for the coal sector in the complex. Using the group method of data handling to build predictive scenarios of coal sector made it possible to see promising options for the future development of the sector of coal industry of Ukraine for the next 5 years and made it possible to see clearly at that scenario can develop the coal industry of Ukraine were forecasted important key indicators.

Through analysis of the dynamics of coal consumption in Ukraine, and such important indicators as coal production, consumption, imports, ash coal shipped - were built predictive models in coal consumption using the group method of data handling, on the above indicators and obtained the following results:

- forecasted the growth of coal production from 79,5 mln t in 2006 to 147,4 mln t in 2020.
- forecasted the growth of coal consumption of 61,8 mln t in 2006 to 236,2 million tons in 2020.
- forecasted the decreasing of the imports of coal from 7, 9 mln t in 2006 to 7,83 mln t in 2020.
- forecasted the decreasing of ash coal shipped from 24,8% in 2005 to 20,9% in 2020.

#### References

1. Autonomiv A.B. World Energy: The state scale, perspective, sustainability, environmental issues, price dynamics of energy resources // Power Station. - 2013.-№5.-55-64 p.
2. Ivahnenko A.G. Adoption decisions based on self-organization/A.G. Yvahnenko, Y.P. Zaichenko, V.D. Dimitrov. - M., "Sov. Radio ", 1976. – 280 p.
3. Volkov A.M. Energy conservation, efficiency and economy of fuel and energy complex of Ukraine in general // Energy policy / Volkov A.M., B.E. Popov, Protsenko O.D., Potryasov S.A. – 2009 - 1.- 31-34 p.
4. Bashmakov I.A. Regional policy to increase energy-efficiency effect from problems to solutions. - M. : TSENEF, 2006 – 192 p.

УДК 621.311

В.С. Степашко, д-р техн. наук, проф.,  
А.Р. Трачук, асп.

Национальный технический университет Украины «Киевский политехнический институт имени Игоря Сикорского»

#### МОДЕЛИРОВАНИЕ ПОТРЕБЛЕНИЯ УГЛЯ В УКРАИНЕ С ИСПОЛЬЗОВАНИЕМ МЕТОДА ГРУППОВОГО УЧЕТА АРГУМЕНТОВ

*В данной работе рассмотрены проблемные вопросы потребления угля по Украине. Проанализирована динамика потребления угля, и предложены методические рекомендации по эффективной добыче, потреблению и использованию угля по всей Украине в целом. Построены и разработаны прогнозные модели потребления угля в Украине с использованием современного программного обеспечения и путем использования метода группового учета аргументов, который позволил построить адекватные прогнозные модели потребления энергоресурсов в системе энергетического баланса Украины. Исследованы и спрогнозированы сценарии потребления угля в целом по Украине.*

**Ключевые слова:** энергосбережение, энергоэффективность, энергобаланс, энергетическая статистика.

УДК 621.311

В.С. Степашко, д-р. техн. наук, проф.  
А.Р. Трачук, асп.

Національний технічний університет України «Київський політехнічний інститут імені Ігоря Сікорського»

#### МОДЕЛЮВАННЯ СПОЖИВАННЯ ВУГІЛЛЯ В УКРАЇНІ З ВИКОРИСТАННЯМ МЕТОДУ ГРУПОВОГО УРАХУВАННЯ АРГУМЕНТІВ

*У даній роботі розглянуто проблемні питання споживання вугілля по Україні. Проаналізовано динаміку споживання та запропоновано методичні рекомендації щодо ефективного видобування, споживання та використання вугілля по всій Україні в цілому. Побудовано та розроблено прогнозні моделі споживання вугілля в Україні з використанням сучасного програмного забезпечення та методу групового урахування аргументів, який дозволив побудувати адекватні прогнозні моделі споживання енергоресурсів у системі енергетичного балансу України. Досліджено та спрогнозовано сценарії споживання вугілля загалом по Україні.*

**Ключові слова:** енергозбереження, енергоефективність, енергобаланс, енергетична статистика.

Надійшла 22.12.2016

Received 22.12.2016